

CJLINE

- HIGH EFFICIENCY IE3 MOTORS
- CERTIFIED FOR 400°C/2H OPERATION
- ABLE TO OPERATE CONTINUOUSLY AT 120°C
- SPECIAL DESIGN TO FACILITATE CLEANING AND MAINTENANCE



IN-LINE EXTRACT
FAN UNITS



CJLINE

The CJLINE series has been designed for the **linear extraction of air or smoke** and can be installed in a horizontal or a vertical position.

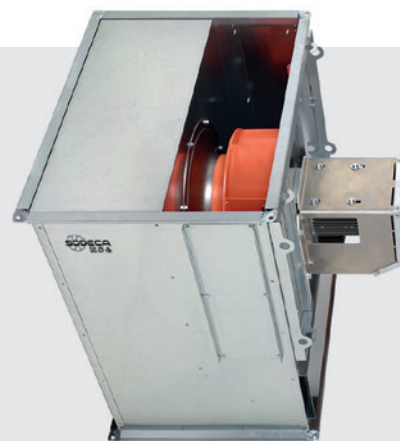



They are particularly suitable for the extraction of hot, grease-laden air in industrial kitchens, and are able to operate continuously at 120°C and 400°C/2h in accordance with **F-400 certification number 0370-CPR-0594**, based on European standard EN-12100-3.

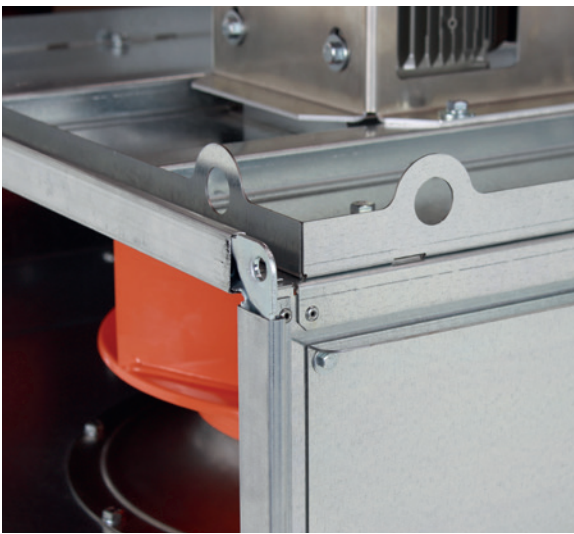

The extract fan nozzle design for connection to rectangular ducts allows for fast, easy installation, and they can also be installed in car parks with rectangular ducts.



The fast access door makes it easy to maintain the unit and clean the impeller.



The extract fans fitted with **IE3 motors and high performance impellers** that permit high efficiency values to be obtained.

CJLINE



400°C/2h air and smoke extract fan units with linear inlets and outlets



400°C/2h and 120°C continuous operation in-line extract fans units for outdoor operation in fire risk zones.

Fan:

- Galvanised sheet steel structure.
- Impeller with reaction blades made of sheet steel.
- Approved in accordance with standard EN 12101-3, with certificate no.: 0370-CPR-0594.
- Linear airflow direction.

Motor:

- Class F motors with ball bearings, IP55 protection and with 1 or 2 speeds, depending on model.

- IE3 efficiency motors for powers equal to or higher than 0.75 kW, except single-phase, 2-speed and 8-pole.
- Three-phase 230/400V-50Hz. (up to 4kW) and 400/690V-50Hz (powers higher than 4kW).
- Maximum temperature of air to be carried: S1 continuous operation -20°C +120°C. S2 operation, 300°C/2h and 400°C/2h.

Finish:

- Anti-corrosive finish on galvanised sheet steel.

On request:

- Extract fans with 2-speed motors.

Order code

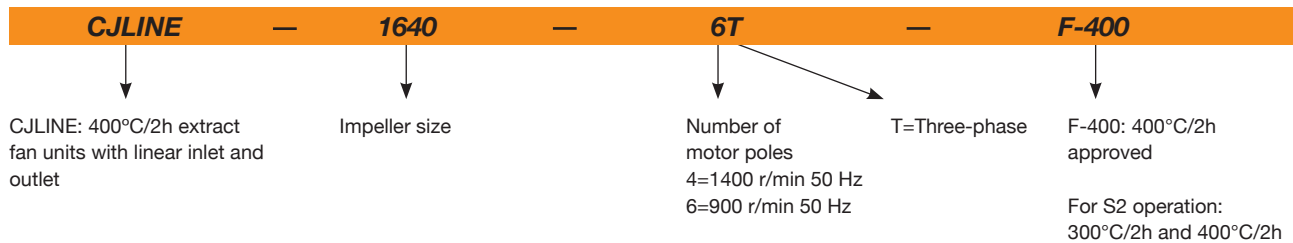

Technical characteristics

Model	Speed (r/min)	Max. admissible current (A)			Installed power (kW)	Max. flow rate (m³/h)	Sound pressure level dB(A)	Approx. weight (kg)	According to ErP
		230V	400V	690V					
CJLINE-1131-4T	1370	1.44	0.83		0.25	1980	51	42	2018
CJLINE-1235-4T	1370	1.44	0.83		0.25	2820	56	54	2018
CJLINE-1640-4T	1385	2.50	1.44		0.55	4430	61	76	2018
CJLINE/H-1650-4T IE3	1430	5.41	3.11		1.50	9650	74	114	2018
CJLINE-1845-4T IE3	1455	4.07	2.34		1.10	6300	65	87	2018
CJLINE-1845-6T	900	2.24	1.30		0.37	4360	57	81	2018
CJLINE/H-1856-4T IE3	1445	10.70	6.15		3.00	13580	77	170	2018
CJLINE-1856-6T IE3	945	3.36	1.93		0.75	8100	59	135	2018
CJLINE/H-2063-4T IE3	1440		10.30	5.97	5.50	20900	79	251	2018
CJLINE-2063-6T IE3	945	3.36	1.93		0.75	9900	61	188	2018
CJLINE-2271-6T IE3	955	6.43	3.60		1.50	13600	65	209	2018
CJLINE-2880-6T IE3	960	12.00	6.91		3.00	22030	67	275	2018



Erp. (Energy Related Products)

Information on Directive 2009/125/EC can be downloaded from the SODECA website or the QuickFan selector programme.

Acoustic characteristics

The indicated values are determined by measuring the sound pressure level and sound power in dB(A) obtained in a free field at a distance equivalent to twice the size of the fan plus the impeller diameter, with a minimum of 1.5 m.

Sound power spectrum Lw(A) in dB(A) per Hz frequency band.

Model	63	125	250	500	1000	2000	4000	8000	Model	63	125	250	500	1000	2000	4000	8000
CJLINE-1131-4T	42	51	57	56	60	60	52	46	CJLINE/H-1856-4T IE3	69	77	91	87	90	90	85	71
CJLINE-1235-4T	49	58	64	63	67	66	59	53	CJLINE-1856-6T IE3	58	64	69	70	73	72	65	60
CJLINE-1640-4T	56	62	67	68	71	73	65	59	CJLINE/H-2063-4T IE3	81	86	93	94	93	90	83	75
CJLINE/H-1650-4T IE3	64	74	82	84	83	85	76	66	CJLINE-2063-6T IE3	60	66	72	72	76	76	68	61
CJLINE-1845-4T IE3	60	66	71	72	75	77	69	63	CJLINE-2271-6T IE3	64	70	76	76	80	80	72	65
CJLINE-1845-6T	52	58	63	64	67	69	61	55	CJLINE-2880-6T IE3	66	72	78	78	82	82	74	67

Dimensions mm

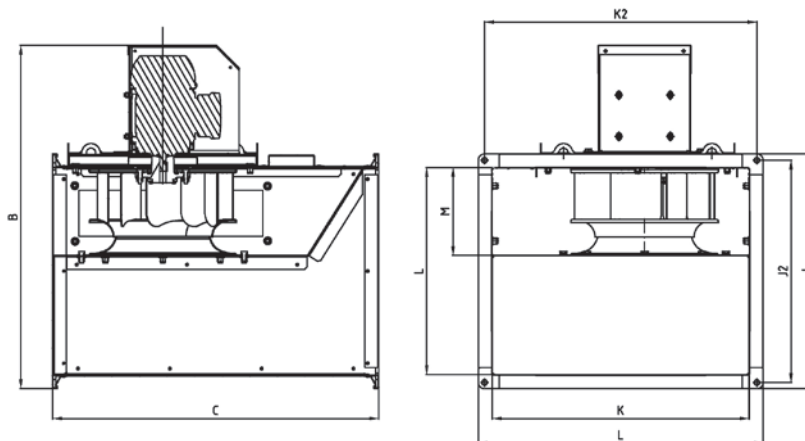

Model	B	C	I	J	J2	K	K2	L	M	ØO
CJLINE-1131	750	710	450	510	483	560	593	620	195	12
CJLINE-1235	790	800	500	560	533	620	653	680	223	12
CJLINE-1640	890	900	560	620	593	705	743	770	245	12
CJLINE/H-1650	1015	1000	630	690	663	800	833	860	338	12
CJLINE-1845	1015	1000	630	690	663	800	833	860	278	12
CJLINE-1856	1185	1250	800	860	833	1000	1033	1060	348	12
CJLINE/H-1856	1220	1250	800	860	833	1000	1033	1060	348	12
CJLINE-2063	1295	1400	900	980	940	1120	1165	1205	410	14
CJLINE/H-2063	1480	1400	900	980	940	1120	1165	1205	410	14
CJLINE-2271	1350	1400	900	980	940	1190	1230	1270	470	14
CJLINE-2880	1580	1500	1000	1080	1040	1250	1290	1330	510	14

Accessories



Characteristic curves

Q= Flow rate in m³/h, m³/s and cfm.

Pe= Static pressure in mmH₂O, Pa and inwg.

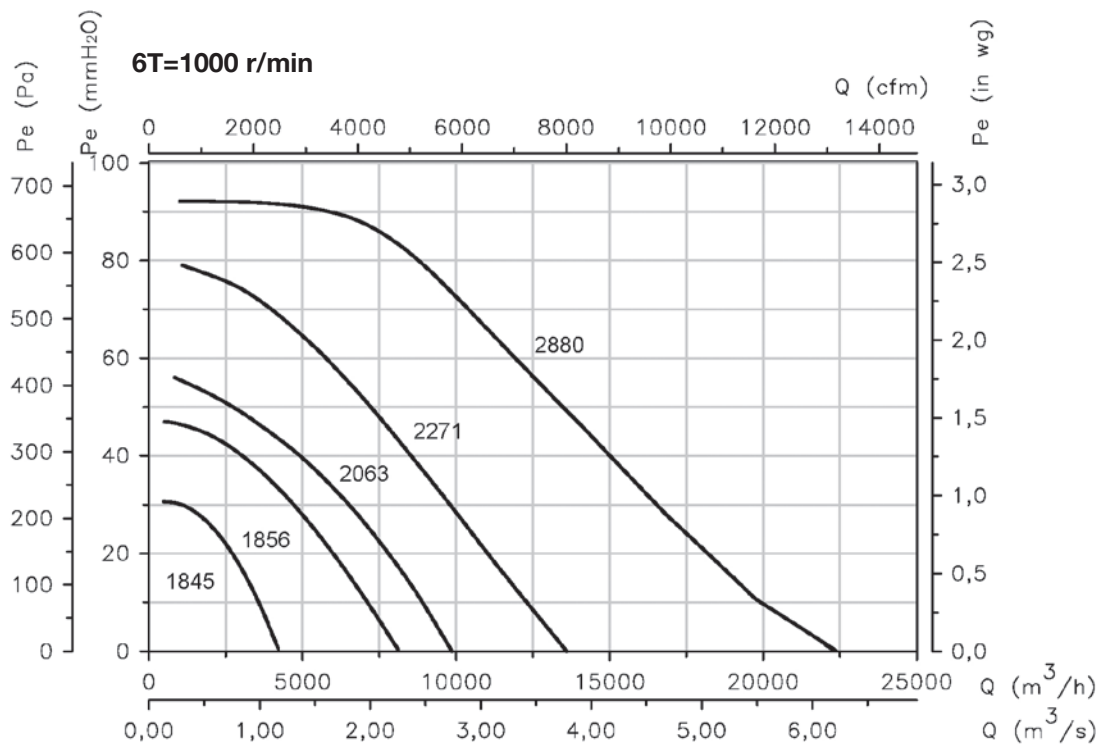
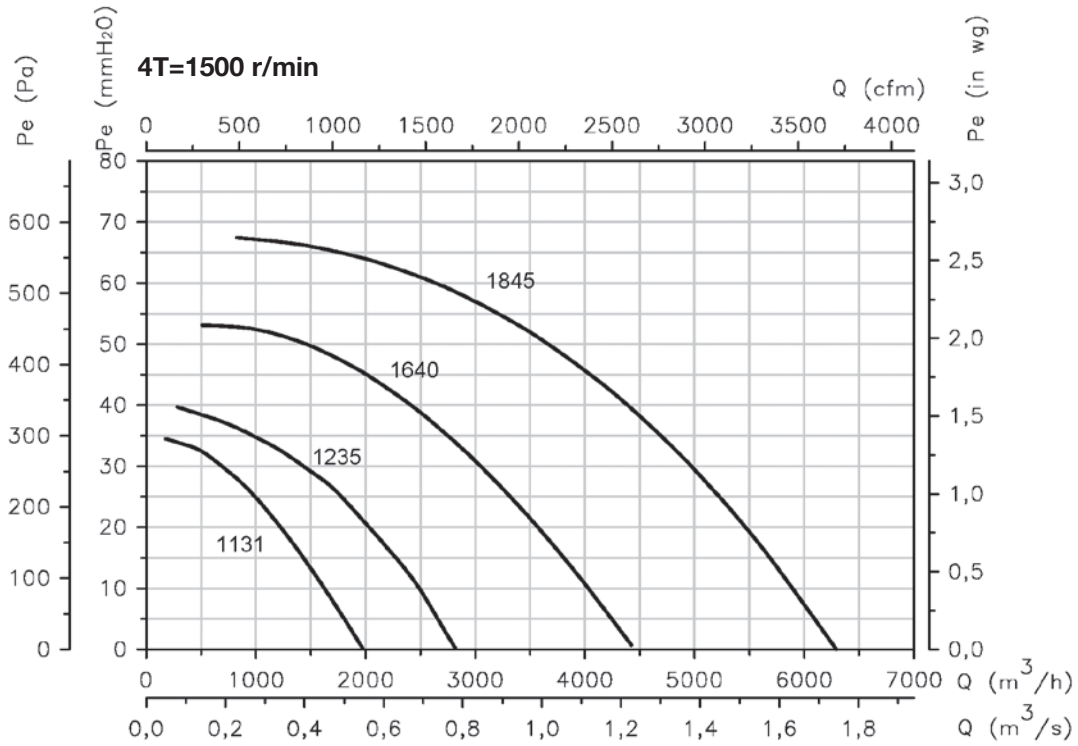

Characteristic curves

Q= Flow rate in m³/h, m³/s and cfm.

Pe= Static pressure in mmH₂O, Pa and inwg.

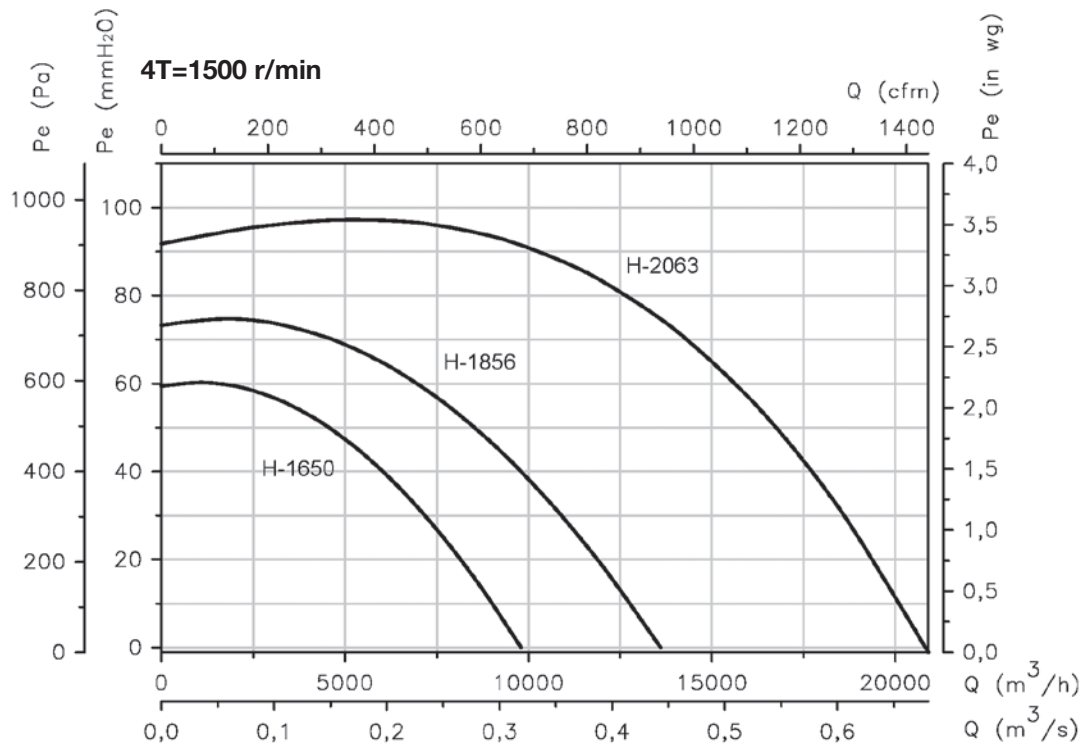

**HEADQUARTERS****Sodeca, S.L.U.**

Pol. Ind. La Barricona
Carrer del Metall, 2
E-17500 Ripoll
Girona, SPAIN
Tel. +34 93 852 91 11
Fax +34 93 852 90 42
General sales: comercial@sodeca.com
Export sales: ventilation@sodeca.com

PRODUCTION PLANT**Sodeca, S.L.U.**

Ctra. de Berga, km 0,7
E-08580 SANT QUIRZE DE BESORA
Barcelona, SPAIN
Tel. +34 93 852 91 11
Fax +34 93 852 90 42
General sales: comercial@sodeca.com
Export sales: ventilation@sodeca.com

**EUROPE****FINLAND****Sodeca Finland, Oy**

HUITTINEN
Sales and Warehouse
Mr. Kai Yli-Sipilä
Metsälinnankatu 30, PL2
FI-32700 Huittinen
Tel. + 358 400 320 125
orders.finland@sodeca.com

HELSINKI
Smoke Control Solutions
Mr. Antti Kontkanen
Vilppulantie 9C
FI-00700 Helsinki
Tel. +358 400 237 434
akontkanen@sodeca.com

HYVINKÄÄ
Industrial Applications
Mr. Jaakko Tomperi
Niinistökatu 12
FI-05800 Hyvinkää
Tel. +358 451 651 333
jtomperi@sodeca.com

ITALIA**Marelli Ventilazione, S.R.L.**

Sr. Christian Tosetti
Viale del Lavoro, 28
37036 San Martino B.A.
(VR), ITALY
Tel. +39 045 87 80 140
Fax +39 045 99 22 24
info@marelliventilazione.com

PORTUGAL**Sodeca Portugal, Unip. Lda.**

PORTO
Rua Veloso Salgado 1120/1138
4450-801 Leça de Palmeira
Tel. +351 229 991 100
geral@sodeca.pt

LISBOA
Pq. Emp. da Granja Pav. 29
2625-607 Vialonga
Tel. +351 219 748 491
geral@sodeca.pt

ALGARVE
Rua da Alegria S/N
8200-557 Cortesões
Tel. +351 289 092 586
geral@sodeca.pt

UNITED KINGDOM**Sodeca Fans UK, Ltd.**

Mr. Mark Newcombe
Tamworth Enterprise Centre
Philip Dix House, Corporation
Street, Tamworth, B79 7DN
UNITED KINGDOM
Tel. +44 (0) 1827 216 109
sales@sodeca.co.uk

AMERICA**CHILE****Sodeca Ventiladores, Ltda.**

Sra. Sofía Ormazábal
Santa Bernardita 12.005
(Esquina con Puerta Sur)
Bodegas 24 a 26,
San Bernardo, Santiago, CHILE
Tel. +56 22 840 5582
ventas.chile@sodeca.com

COLOMBIA**Sodeca Latam, S.A.S.**

Sra. Luisa Stella Prieto
Calle7 No. 13 A-44
Manzana 4 Lote1, Montana
Mosquera, Cundinamarca
Bogotá, COLOMBIA
Tel. +57 1 756 4213
ventascolombia@sodeca.com

PERU**Sodeca Perú, S.A.C.**

Sr. Jose Luis Jiménez
C/ Mariscal Jose Luis de
Orbegoso 331. Urb. El pino.
15022, San Luis. Lima, PERU
Tel. +51 1 326 24 24
Cel. +51 994671594
comercial@sodeca.pe

RUSSIA**RUSSIA****Sodeca, L.L.C.**

Mr. Stanislav Alifanov
Myasisheva str, 1, room 603
Business Center "Chaika"
140180 Zhukovskiy
Moscow region, RUSSIA
Tel. +7 495 955 90 50
alifanov@sodeca.com



www.sodeca.com

